

Creative SCIENCE & RESEARCH

Alternative Energy

THE LORD GOD
SAID, "LET THERE
BE LIGHT," AND
THERE WAS LIGHT.
AND GOD CALLED
THE LIGHT "DAY,"
AND THE DARKNESS
"NIGHT." AND GOD
CREATED THE HEAVENS
AND THE EARTH,
AND ALSO CREATED

www.FuellessPower.com

We want to help you get off the grid!
Produce your own electricity for your entire home!
Make your own free energy electric car!

Alternative energy research since 1992
PO BOX 557 New Albany, Indiana 47151-0557

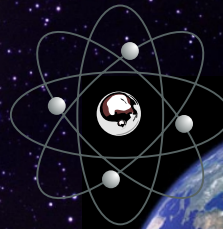

Free Energy Motors - Generators

www.FuellessUSA.com

INTRODUCTION

The reason we made this catalog was to raise money for research in the area of alternative energy as well as to make public our findings and discoveries on the Fuelless Engine as well as our new low rpm SP500 AC / DC Generator. It is our idea to slowly and carefully introduce these devices to the world by allowing people like yourself to build them in the privacy of your own home or garage. Many of our plans are step by step and easy for many home owners to build. These plans are well illustrated and professionally done and include color photos as well as many drawings.

We offer a demo video of our Fuelless Engine showing our low horsepower motor running as well as our larger horsepower motor. Our videos are clear and show many closeups. All of our videos are available on DVD or on Computer CD as well as download. Many schools and universities have purchased our plans and have built our devices. We have hundreds of letters from customers who have built our devices. These letters can be seen at: http://www.fuellesspower.com/23_Satisfied_Customers.htm or www.FuellessUSA.com or www.FuellessPower.com



Don't wait until disaster strikes! Be prepared! Every home in America should have an emergency back up system **right now!** Americans must stop relying on the power companies to provide them with electrical power for their homes and business. Have a plan of action before it happens! Think about it. What if your power was shut down for 2 weeks or the entire winter? What would you do for heat or electricity? The sad part is, very few people will listen to my warnings! At least buy a few extra candles, and stock up on some food and water.

Ask not what your country can do for you, ask what you can do for your country.

“ John F. Kennedy “

**You can start helping America by helping yourself! Be prepared for any and all emergencies!
Waiting until the last minute will be to late!**

Question: Is it true you once sold Fuelless Heater kits as well as a Fuelless Engine kit?

Answer: Yes at one time in the early 1990's, but we have to be careful about what we say. We are selling information that has been suppressed for many years and is still being suppressed to this day! We sold many research prototype kits, but we had to stop! At this time, we are only allowed to sell the plans and videos to our inventions! You can only build our devices for personal use only. You can not manufacture or sell these devices. The more people we sell these plans to, the closer we will be to freeing the world from the gas and power companies.

Free Energy is everywhere! The earth is loaded with free energy and acts as a motor in a perpetual motion state. The earth is the biggest perpetual motion machine or motor on the face of the earth. Hydrogen and oxygen atoms are also a form of free energy constantly being reused over and over! A coil of wire induced by a DC current and then turned off will produce free energy from a collapsing magnetic field! Consider your body as a free energy generator! Our bodies are loaded with free electrical energy provided by the sun, food and the water we drink.

Thank you
David Waggoner
David Waggoner

E-mail: Salesdept@FuellessPower.com
Phone: 1-812-945-5839

THE FUELLESS ENGINE PLANS

362-RC350

The Fuelless™ ENGINE

Copyright 2011 Creative Science

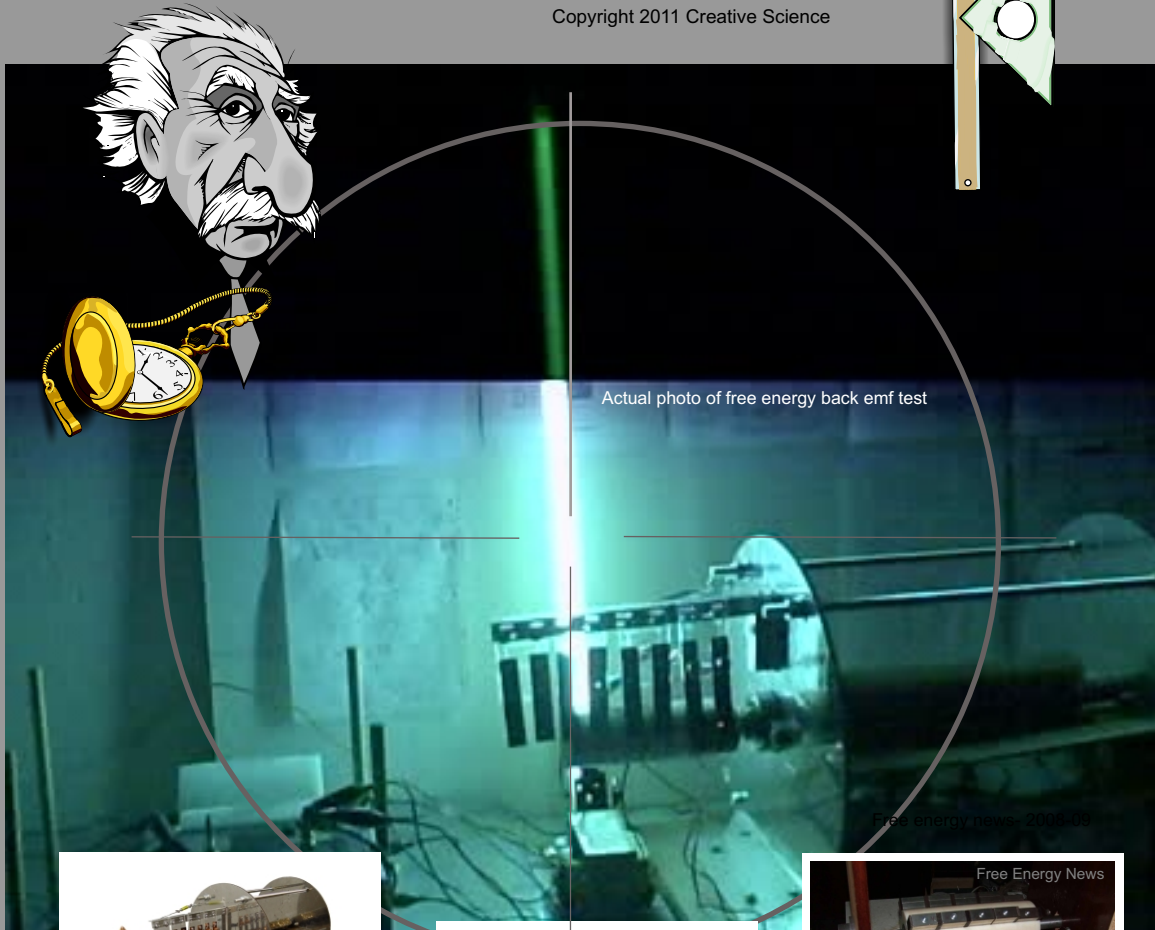
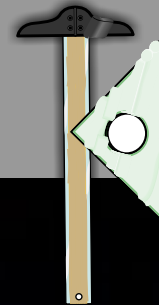

Actual photo of free energy back emf test

Free energy news- 2009-09

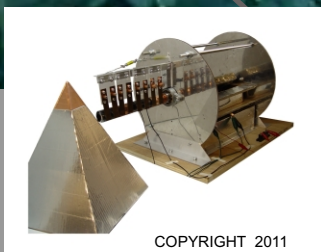

COPYRIGHT 2011

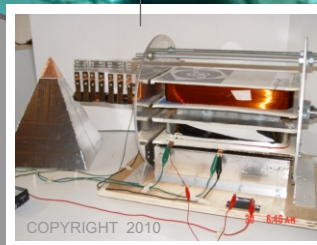

COPYRIGHT 2010



This photo was sent in by one of our customers

New! Advanced Coil Technology - Designed By Creative Science & Research!

Front Cover

Fuelless Engine Plans....only \$70.00

Next page >



The Fuelless ENGINE

Invented by David Waggoner of New Albany, Indiana USA
New Albany is located right across the Ohio river from Louisville Kentucky

See our website for more information: www.FuellessPower.com

FREE ENERGY - FREE POWER FOR YOUR HOME, GARAGE OR CAR!

These type of motors have been seen and demonstrated on the Johnny Carson Show, as well as many local TV news and radio shows all around the country in the early 1970's and 1980's. These motors can be designed to run at any rpm.
From 0 - 5000 rpm

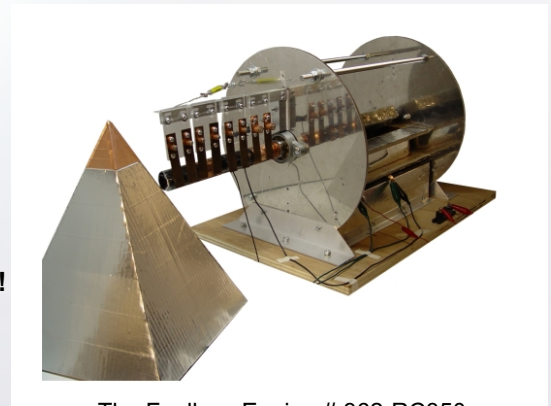

The Fuelless Engine # 362-RC350

I have spent hundreds of hours testing and designing this device! When you buy these plans you will not be disappointed! There is no other motor like it! We have customers that have successfully built this motor. We have made it easy for just about anyone to build this motor in the convenience of there own home, garage or basement. Use this motor to power our SP500 AC generator to generate AC electricity! The motors rpms can be designed to be adjustable. Our prototype designs can be scaled up to run at any horsepower you may desire.

These plans are loaded with information! Plans are professionally done and easy for many home owners to understand and build. David takes you step by step in building this awesome free energy device! Loaded with color photos, professional drawings and illustrations. Our free energy video shows our motor's running inside and out. Many clear and crisp close ups! David demonstrates our large hp motor and at the end of the video he demonstrates one of our smaller free energy motors, input energy versus output energy! By viewing this video you will see that our motor clearly demonstrates more output than input energy!

MANY MAGAZINE ARTICLES HAVE BEEN WRITTEN ABOUT THESE TYPE OF MOTORS! You may have read about us in the 1996 July Issue of Exotic Research magazine. Popular Science has also done a few articles on free energy in the early 1900's and then they suddenly stopped? See our website for more details.

Plans and videos are available on download or on computer CD. Download links can be sent by E-mail. Cd's can be sent by air mail. The Fuelless engine is a free energy electric motor that just about anyone can build. Fuelless is a trade name / brand name derived in 1992 from our Fuelless gravity motor. Free energy is collected from the motors radiant energy spikes and placed back into the motor to raise the rpms and horsepower to run our Sp500 generator. Derived from Nikola Tesla's radiant energy free energy discoveries over 100 years ago. Suppressed technology, but plans are open to the public for immediate purchase! Our devices can legally be built in the privacy of the home owner and used for home personal use.

Ph: 1-812-945-5839

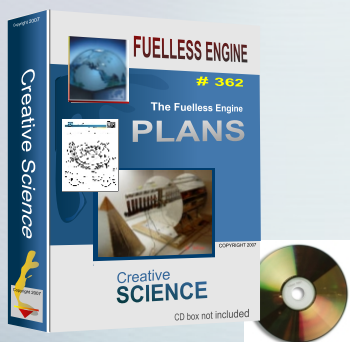

Fuelless Engine Plans 1 - 50 hp \$40.00

Plans are **48** pages long!

362

Fuelless Engine Plans 50 - 350 hp \$70.00

Plans are **115** pages long!

362-RC350

DVD VIDEO.....only \$29.95

* Available on DVD, CD or DOWNLOAD

Order # 361V

GUARANTEED TO WORK OR YOUR MONEY BACK!

THE SP500 AC OR DC GENERATOR PLANS

Sp500

Customer User Code: ID #

The SP500 GENERATOR

Copyright 2009-2011 Creative Science

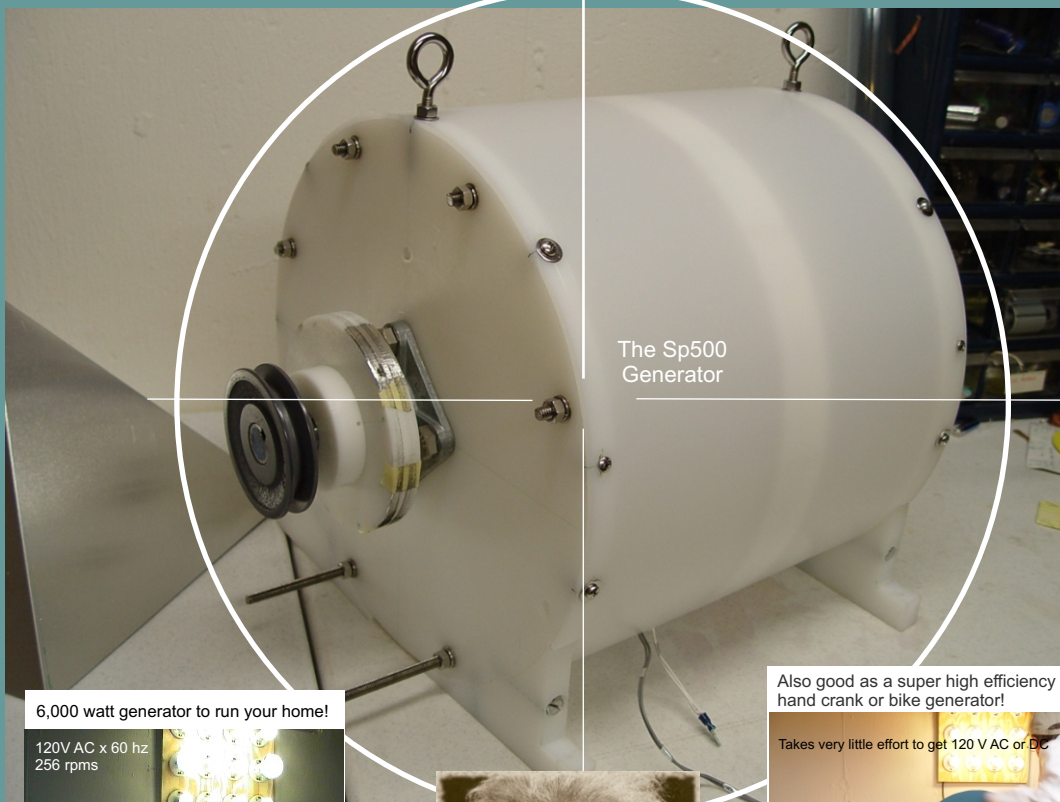

The Sp500
Generator

6,000 watt generator to run your home!

120V AC x 60 hz
256 rpms

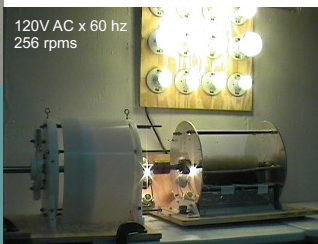

Can be scaled up to output 25Kw or more.

Also good as a super high efficiency
hand crank or bike generator!

Takes very little effort to get 120 V AC or DC

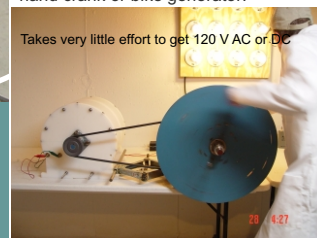

COPYRIGHT 2009 - 2011

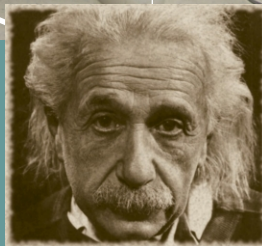

New! Advanced Coil Technology, By Creative Science & Research!
Www.FuellessPower.com Phone: 1-812-945-5839

Sp500 Generator Plans....only \$70.00

Next page >



The SP500 GENERATOR

A SUPER HIGH EFFICIENCY HOME GENERATOR!

Low rpm design
50 to 3600 rpms
0 - 120 V AC or 220 to 240 V AC or DC x 50 to 60 Hz

**Designed for our Fuelless Engine Motor!
A High Efficiency AC or DC Generator**

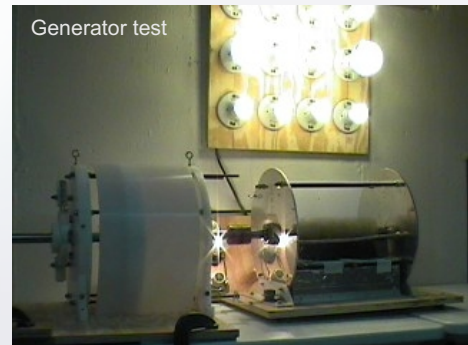

Sp500 Model # 4, lighting 12 light bulbs!

You can run your entire home with this type of generator!

Detailed AC - DC Generator Plans!

This is a new type of AC or DC generator designed by David Waggoner.

New Technology for the 21st century, and designed as an easy homemade device that anyone can build! A breakthrough in AC - DC generator design! Great for Home use as well as industrial use! It was designed to operate with our Fuelless Engine, Windmill, and Fuelless Gravity Engine devices but can be operated by other means as well. Rated at about 6kw to 8kw x 120V AC. Can also be built to run at 14.5V DC, to charge a battery bank for home inverter use.

Very high efficient! Unlike any other generator seen today! Can easily be designed to operate at much higher voltages other than 120V AC. Great for many high voltage projects. The plans are 137 pages long and are packed with color photo's, drawings and instructions that are easy to follow.

Included in these plans are the horse power / generator formulas. Learn how much horsepower it will take, to achieve a certain wattage or voltage output. Plans also include a rpm formula guide. This will show you how many rpm's it will take to get a 120V AC x 60 Hz or 50 Hz, and how many coils and magnets will be needed for certain rpm's to stay at the standard 60 Hz or 50 Hz cycles for common household current. Covers rpm's from 500 to 3600 rpm's.

For those needing 220V AC or 240V AC that live outside the USA, our SP500 can be designed to run at these voltages as well. We know of no other research group that has a generator like this! We have made it easy for you to build at home. You do not have to be an electrical engineer to build this.

More info on next page >



Sp500 Generator Plans Only **\$70.00**

Order # Sp500

**GUARANTEED TO WORK OR
YOUR MONEY BACK!**



More on next page >



The SP500 GENERATOR

I discovered this special type of generator when I was working on a new prototype for a free energy electrical motor. I placed my array of coils next to moving N38 Neodymium magnets and what I saw on my volt meter just blew me away! I could not believe what I was seeing. The electrical output was like nothing I had ever seen before! **Very high efficient!** I don't think there is any other generator in the world like our SP500 Generator, and it is not that hard to build!

I personally guarantee The SP500 to work or your money back!

Thank you
" David Waggoner "
Owner / Research Scientist

Our SP500 Generator working lab prototype can generate up to about 6,000 watts at 120V AC x 60 HZ. The generator can be scaled up to run at up to 20,000 watts! You can also arrange the coils to output 220V AC x 60 Hz, or 240V AC x 50 Hz

Designed to be used with our Fuelless Engine, or can be used with any other free energy or high efficiency motor or windmill device. Also great as a high efficiency hand crank generator or bike generator to charge batteries to power inverter's and more!

Easy to build! We provide step by step plans on how to build our Sp500 model 1, as well as plans on how to build our Sp500 model 4.

A list of supplies and parts and where to buy them are provided. If you can not find the parts and supplies in your own home town, we have companies on the internet that can ship them right to your front door.

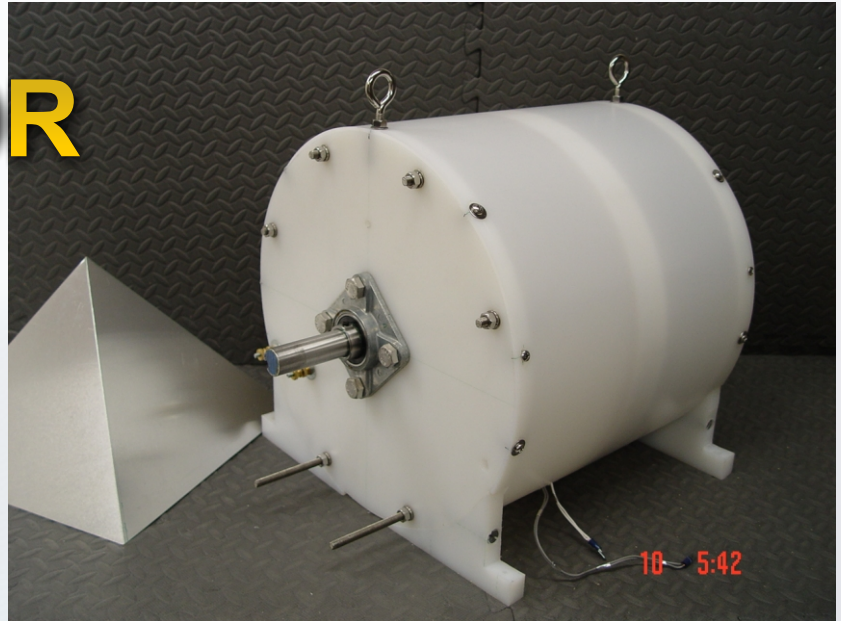

Photo of a 6kw Sp500 AC Generator. Can also output DC if desired. *From our Sp500 Model # 4*



A close up of one of our special Sp500 coils with a two part epoxy coating. *From our Sp500 Model # 4 included in the plans.*



Question?

I want to build a Sp500 that is easy and affordable to run my home on, what do you suggest?

Answer:

Although the Sp500 generator can be built to run at any voltage and can be designed to output 120 VAC, 220 VAC or 240 VAC, you may want to run the generator to run at about 14 to 15 VDC. If you went direct from the Sp500 generator to your home the generator would have to run 24 hours a day 7 days a week, which equals wear and tear on the generator and motor.



Why DC? By using the Sp500 as a 12 volt x 60 to 200 amp battery charger you can run it only when it is needed to charge your batteries, which could only be 2 to 3 hours per day (depending on the size of your home or business), **A small home would need about 4 deep cycle batteries, rated at about 245 amp hours each = total 980 amp hours, see plans for more details.** These batteries can be connected in parallel to increase the amp hours. The larger the amp hours the better. TIP: It is best to only charge 4 batteries connected in parallel at one time, to get an even charge and longer life from your battery bank. Industrial batteries or large fork lift batteries are the best and can last up to 27 years.



12 Volt DC Batteries



8,000 watt inverter
See our plans for more details

An inverter must then be connected to the battery banks to increase the 12 or 24 VDC to 110 to 120 VAC. You can do all this yourself which is very easy to do, or you can hire a qualified electrician to connect the inverter to your main breaker box. For smaller home power systems you can use a 12 to 15 amp extension cord rated for generator use, and run it into the house and plug your appliances and or lights into it. But do not go over the wattage rating of your inverter or it will shut off. If your on a budget you can purchase 1 to 4 small MK batteries at 105 amp hours each, with a small 750 watt to 1200 watt inverter as emergency back up for one TV, refrigerator and a few lights. If you decide to use our Sp500 Generator to go direct. You will not need the batteries or an inverter. You will need the Fuelless Engine to run the Sp500 generator.



SP500 GENERATOR

Copyright 2009-2012 Creative Science & Research

Www.FuellessPower.com PH: 1-812-945-5839

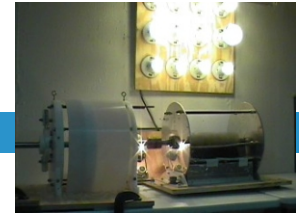

The Fuelless Engine

The Sp500 Generator

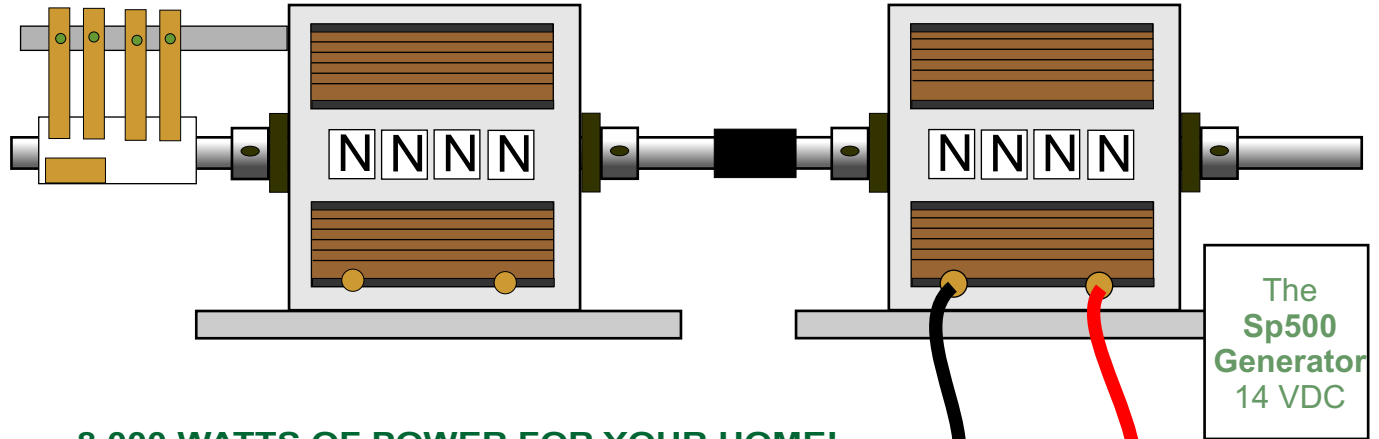

8,000 WATTS OF POWER FOR YOUR HOME!

The Sp500 Generator 14 VDC

Option 1

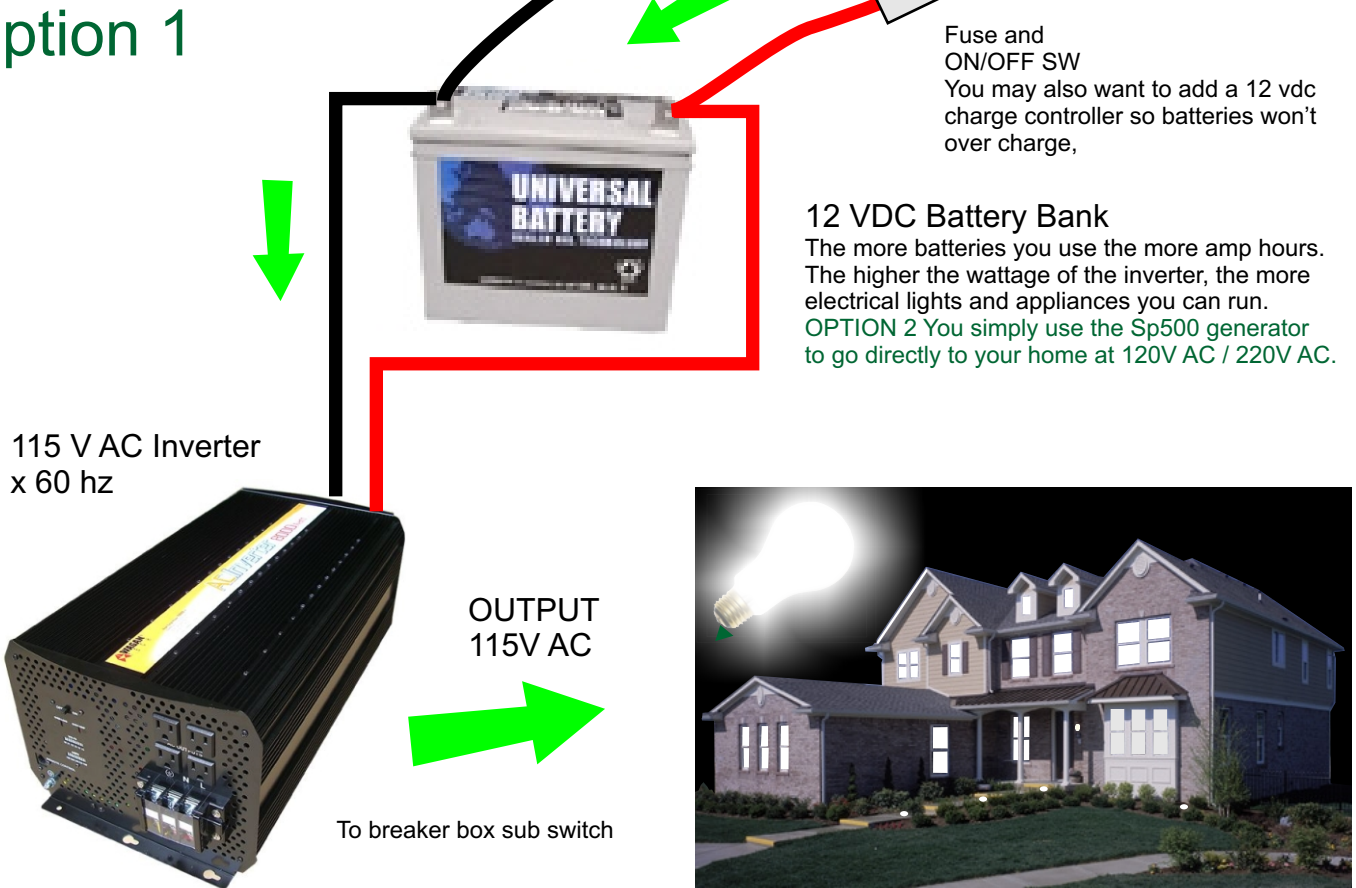



RPM Formula For Disk Type Generator

(For going direct from generator to a home)

Below is the rpm formulas for getting the desired 120 VAC x 60 Hz USA standard electricity. The formula is for standard cylinder type generators but could also be used for our disk type Sp500 generator as well. Our disk generator has the pole magnets, North and South, on two separate disks. These disk move and are considered the rotor. The stator disk does not move and is sandwiched in between both magnet disks. The stator has the field coils or generator coils glued into the plastic or wood disk. As the magnets pass

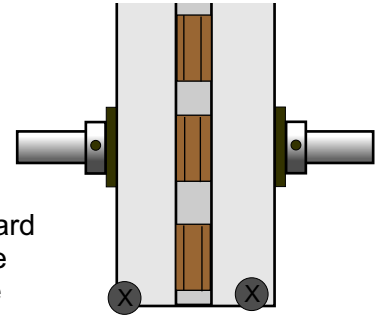

Cylinder type (Example only of a common cylinder type generator. The drawing is not of a disk type.)

The cylinder type formula can also be applied to the disk type generator as well.

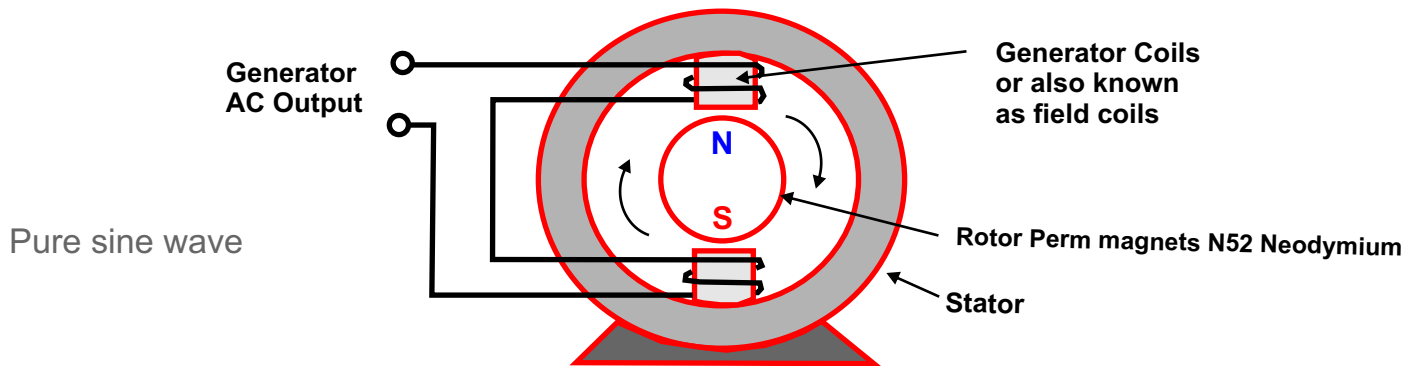

Example: A 2 pole generator has one North and one South pole on the rotor (The permanent magnets), and two generator coils (or also called field coils) on the stator. A 4 pole generator has 4 poles on the rotor and 4 poles on the stator. This can also be applied to disk generators as well. An 8 pole generator has 8 coils and 8 magnets. You can keep adding poles to lower the input rpms needed to generate 60 hz or 50 hz x 120 V AC.

Poles	120 V AC x 50 hz	120 V AC x 60 hz	12 VDC - 18 VDC w/diode
2	3000 rpm	3600 rpm	360 rpm
4	1500 rpm	1800 rpm	180 rpm
6	1000 rpm	1200 rpm	120 rpm
8	750 rpm	900 rpm	90 rpm
10	600 rpm	720 rpm	72 rpm
12	500 rpm	600 rpm	60 rpm
14	428 rpm	514 rpm	52 rpm
16	375 rpm	450 rpm	45 rpm
18	333 rpm	400 rpm	40 rpm
20	300 rpm	360 rpm	36 rpm

NOTICE: If you live in a country that uses 220 or 240 volts AC, you may need to double the amount of turns of wire, the more turns the higher the voltage output. The amount of turns for 120 volt AC coils will depend on what size wire you choose to use. The number of turns will vary. Build one coil and test it first. 4 pole with one coil = 30 volts.



SP500 GENERATOR

Copyright 2009-2012 Creative Science & Research

Www.FuellessPower.com PH: 1-812-945-5839

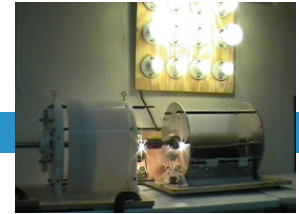

High Efficiency Hand Crank Generator!

Not only can you use the Sp500 generator to run your entire home directly, but it can also be used as a super high efficiency hand crank generator for emergency back up. This generator would also be great for using as a bike generator. Hook the Sp500 generator to an exercise bicycle and get two times the output than a normal DC or AC bike generator system would produce! Exercise and store energy at the same time. This would also be great for third world countries and emergency fall out shelters for homes and hospitals. Charge batteries or use as direct generator power for small loads.

The photo below is a quick experiment we put together to show how powerful and easy it is to light 8 light bulbs using the hand crank method. It took very little effort to get 120 V AC from our specially designed Sp500 Generator! No one in else in the world, that we know of can claim this!



This hand crank generator can easily light a 100 watt bulb, fluorescent bulbs, or an entire house loaded with LED super bright white light bulbs. Great as an emergency back up system. Using an exercise bike to replace hand cranking will give you much more energy, and is much more efficient!

This is a 6,000 watt generator, so the more horsepower you put in the more wattage and amperage you can get out. Not exceeding 6kw. You can build the generator larger by scaling it up to get more wattage. Up to about 25,000 watts, see our plans for more details. It takes about one horsepower per 745 watts. Of course you do not need a bike generator if you build our Fuelless Engine motor to turn the generator to power your home.

THE FUELLESS HEATER PLANS

878p

The Fuelless Heater PLANS

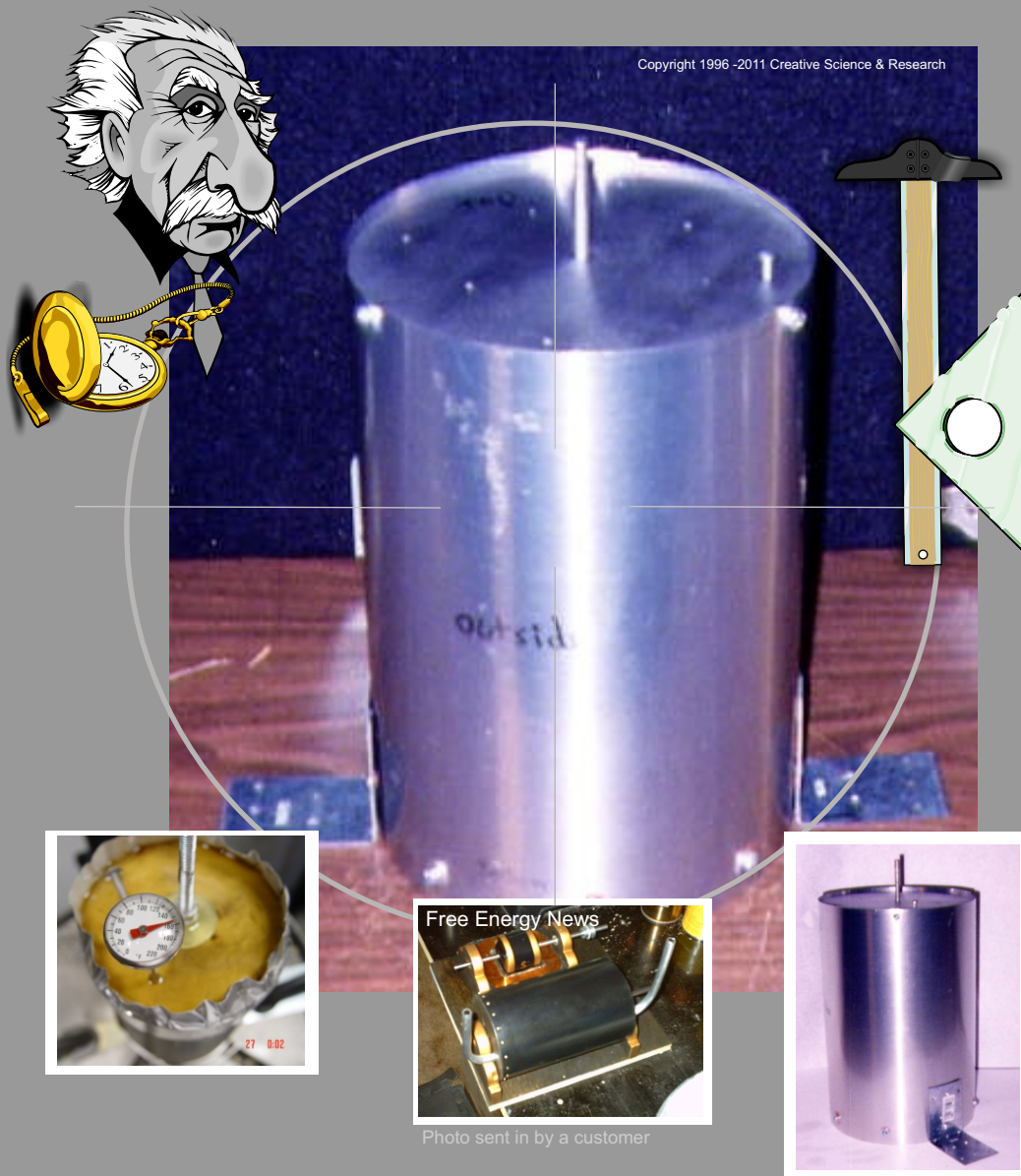

Front Cover

Fuelless Heater plans....only \$40.00

Next page >



The Fuelless HEATER

FREE HEAT FOR THE REST OF YOUR LIFE!

**NO MORE HEATING BILLS! • SAFER THAN NATURAL GAS!
NO FLAMES • NO GASES • RUNS QUIET!**



Small Space Heater, rated at about 260 degrees F or more!

Learn the secret of this amazing heating device! Simple in design and easy to build!

It is now possible to convert any gas or electric furnace into a free energy heating source! Use as a stand alone heating device, or as a second heater to lower your heating bills for your entire home. As low as \$20 per month (and that's just the cost to run a fan blower to blow the heat around your home). This invention uses a zinc rod and motor oil inside of an zinc or sheet metal outer casing and more. The Fuelless Heater has over three US Patents. Our plans and video show you how to construct a smaller space heating unit, and includes a drawing of a larger home unit. A US patent with drawings are also included in this package. The heat can then be controlled by using your old thermostat. Your thermostat will turn the unit on and off as needed, or you can use the smaller unit as a room to room space heater.

We suggest that you build our small space heater first. The larger you build this device, the more BTU's you will get. *The above photo shows just one part of the main heating unit.* A small one hp motor can then be added to blow the heat around a room or your furnace air duct system. We suggest using our Fuelless Engine motor as an actuator. The heater does require a motor of some type if the Fuelless Engine is not used.

HOW IT WORKS: To start we use a 7" x 11" metal drum, (Which is the outer drum) Then motor oil is poured into the inner can, It does not use oil, it only uses the atoms from the oil which is very safe to use. A small amount of oil is added to the bottom of the can. A zinc rod is placed in the center of the inner drum, more devices and parts are then added. The unit is turned on, and the end result is heat! A large amount of safe heat is then created, much like a spiral vortex heating effect! This then creates a strong chain reaction within the atoms of the oil creating the enormous amount of heat! The zinc rod can be purchased at most hardware stores, or on the internet. Zinc plated long bolts can be used as well. Most all hardware store nuts and bolts are zinc plated. Other types of liquids could be used as well, such as water, vegetable oil etc.

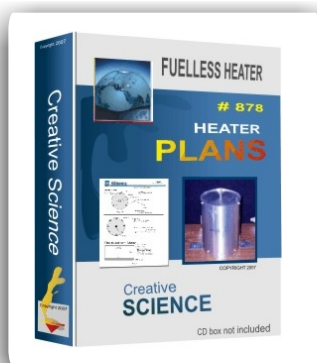

Fuelless Heater Plans

Only **\$40.00**
878P

* Available on CD or Download.

Order line:
1-812-945-5839



Plans and Video

Only **\$59.95**
878PV

* Step by Step Video

**GUARANTEED TO WORK OR
YOUR MONEY BACK!**

RUN YOUR CAR ON WATER

FFWH

Customer User Code: ID # 8890T233

The Fuel From Water

Copyright 2010 Creative Science & Research

PLANS

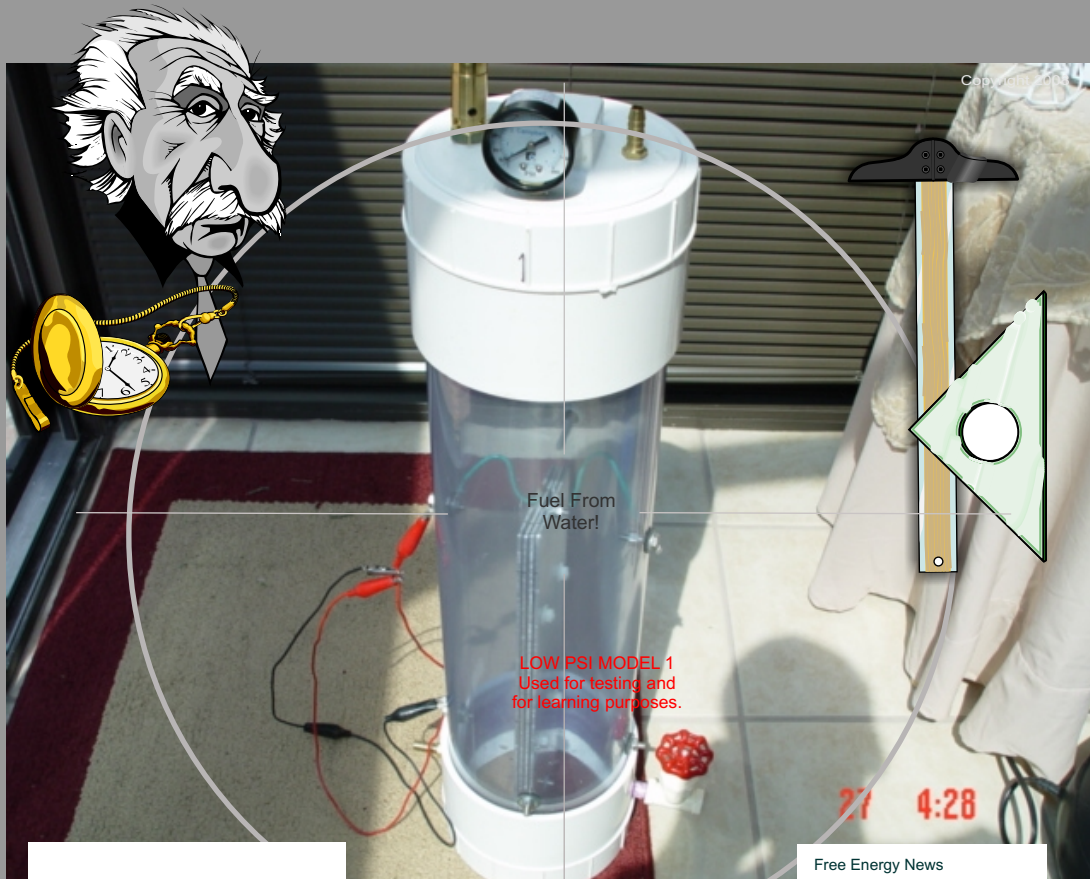

Hydrogen

Copyright 1996 - 2012
Creative Science & Research

Front Cover

Fuel from water plans....only \$20.95

Next page >



Turn Water Into Hydrogen!

Copyright 1996 - 2012 Creative Science & Research

PO BOX 557 New Albany, IN. 47151 USA

FUEL FROM WATER PART 1

Learn how to build a **Fuel Cell!** Turn water into usable energy by using electrolysis. Easy for most homeowners to construct and apply. Water is made up of hydrogen and oxygen atoms, and it is not hard to split the two. Electricity is applied to tap water or free rain water. With this fuel cell you can store the gases produced in propane tanks. You can then use the gas to cook or heat with as well as run a gasoline engine. Can be used as an additive to gas or used by itself. Hydrogen burns very clean! This can all be done right in your own backyard.

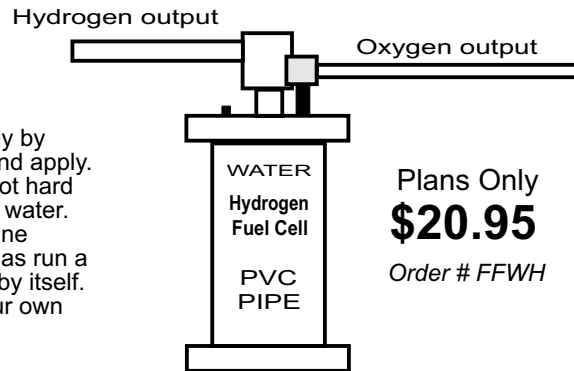

Plans Only
\$20.95

Order # FFWH

PART 2 *Fuel From* WATER

You will also need The above Fuel From Water Part 1 in order to understand part 2.

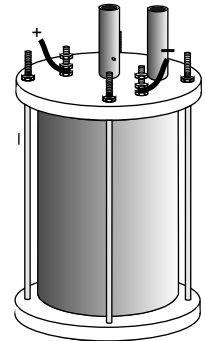
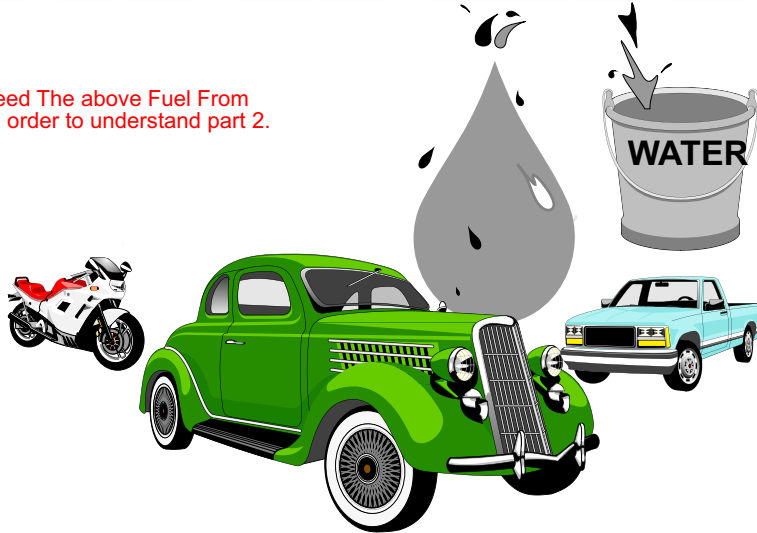

Run your car, truck or home generator with water!

Many industrial vehicles as well as some cars in America already run on propane gas as well as natural gas. This helps set the stage for hydrogen as an alternative fuel for cars or trucks. Hydrogen gas can replace propane gas using just about the same set up and configuration as propane driven vehicles. Many back yard researchers world wide are already using water as a alternative fuel. Now we may see America getting closer to seeing this fuel on the open market! But some of our customers are not waiting! Many right now are building these fuel cells to run their gasoline engines and you can to! Think about it, instead of going to a gas station to fill up on high price gas, you simply fill your tank with water instead. I have talked to an old man down in Kentucky who has been secretly running his car on water for years! The old method has been to store the hydrogen and the oxygen gases in large heavy storage tanks, which has proven to be very dangerous! But there is a new method that is safe and easy to do, by simply storing the water and splitting the gases on demand and directing them into the carburetor. *You will need the Fuel from water part 1 plans as well.*

Plan with US Patent only **\$20.95** Order # SMW All plans available on computer CD or by download.

THE AIR ENGINE PLANS

#400

Copyright 1996 - 2012

AIR ENGINES

AIR CARS

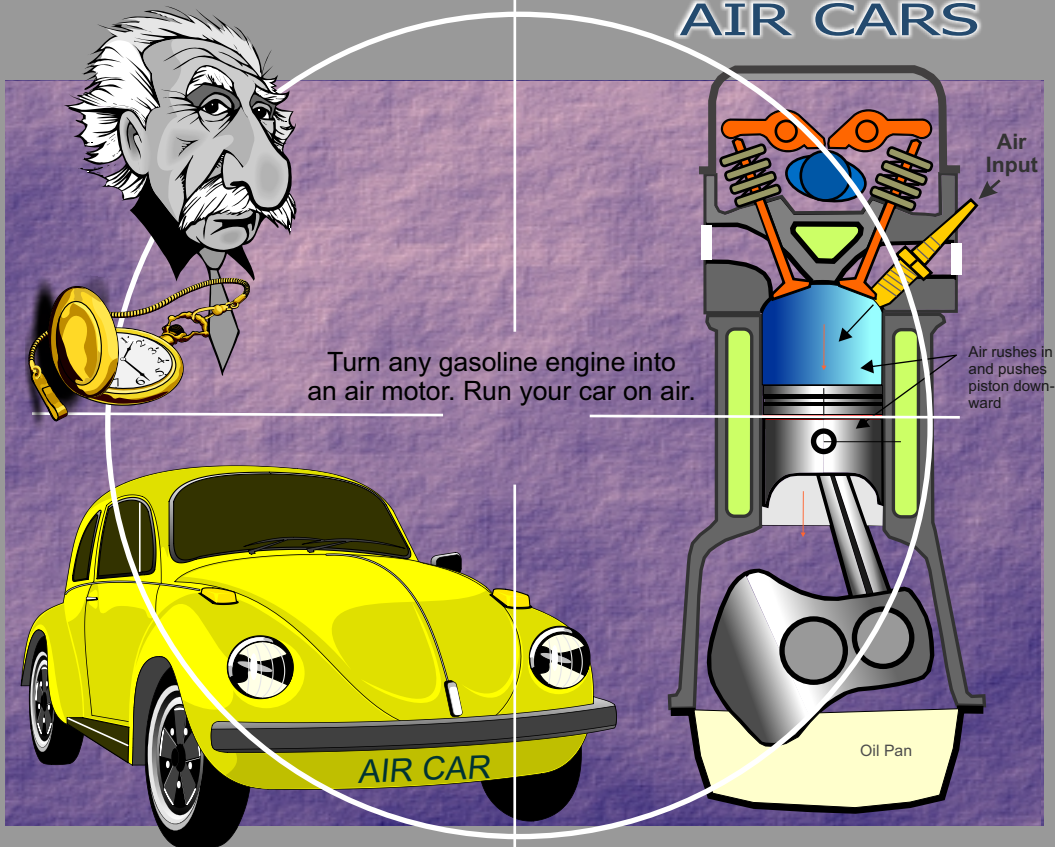

Turn any gasoline engine into an air motor. Run your car on air.

Free energy news



Vane Type

5 HP Air Motor - Manufactured



Vane Type

51 HP Air Turbine Motor - Manufactured



Vane Type

9 HP Air Motor - Manufactured

Air motors can be made to run a car, motorcycle or bike!

The Air Engine Plans....only \$20.95

Next page >



The Air Engine

Copyright 2009-2012 Creative Science & Research

Www.FuellessPower.com PH: 1-812-945-5839

PO BOX 557 New Albany, IN. 47151 USA

THE AIR ENGINE

AS SEEN ON **Headline News**
Jan. 1998

Run Your Car On Compressed Air!

NEEDS NO GAS!

Clean air with no deadly fumes.

The gas tank is removed and thrown away! The carburetor is not needed. The engine is easily converted to run on compressed air using air hose and solenoid switches, that fit directly into the spark plug holes. Each piston is then timed by using the existing timing system of the engine, using 8 small electrical on/off solenoids. This Air Engine is just as powerful as a V-8 gasoline engine, but is far better and has a more powerful take off. Any engine or motor that runs on gasoline or propane can be converted to run on compressed air, and is very high efficient! The above US Patent drawing is much more simple than it looks. You do not have to add all the extras as shown. Any size hp motor can be converted. It is best to start with a small lawn mower engine. to get the hang of it.

These plans are loaded with information. But, you may also want to consider building our Fuelless Engine motor and SP500 AC Generator. They are much more high efficient than air motors, will last longer and are easier to build using our step by step plans.

Ph: 1-812-945-5839

GUARANTEED TO WORK OR YOUR MONEY BACK!

The Air Engine Plansonly **\$20.95**

Order # 400

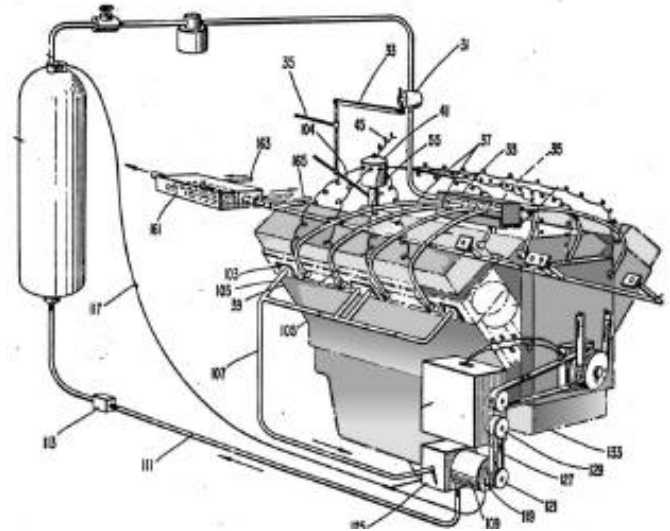

Convert any type of gasoline piston engine / motor, to run on air . The gas tank and carburetor is not needed!



Homemade SOLAR CELLS

Copyright 2009-2012 Creative Science



LEARN HOW TO MAKE YOUR OWN SOLAR CELLS

Written By Creative Science & Research!
Www.FuellessPower.com Phone: 1-812-945-5839

FRONT
CVR



Homemade Solar Cells

Copyright 2009-2012 Creative Science & Research

Www.FuellessPower.com PH: 1-812-945-5839

PO BOX 557 New Albany, IN. 47151 USA

How a Solar Panel Charging System Works

Example of just one solar panel.

First you make your own homemade solar cells. Each cell must then be soldered together in series and parallel to increase voltage and amperage. You then build a weather proof case to attach and glue the solar cells to. This can be wood or aluminum with Lexan clear plastic (bullet proof), or safe glass. The output of the solar panel is then connected to a 12v x 5 amp fuse using #12 or #14 AWG wire. You will also need to add a solar charge controller which you can buy at any online solar supply house, they are not that expensive. The controller will help keep the battery from over charging when the sun is out. From the battery to an inverter which changes the 12V DC to 110V AC or 120V AC x 60 Hz. You can then direct the 120V AC to your home



One Solar Panel with 36 solar cells

Copyright 2009-2012 Creative Science

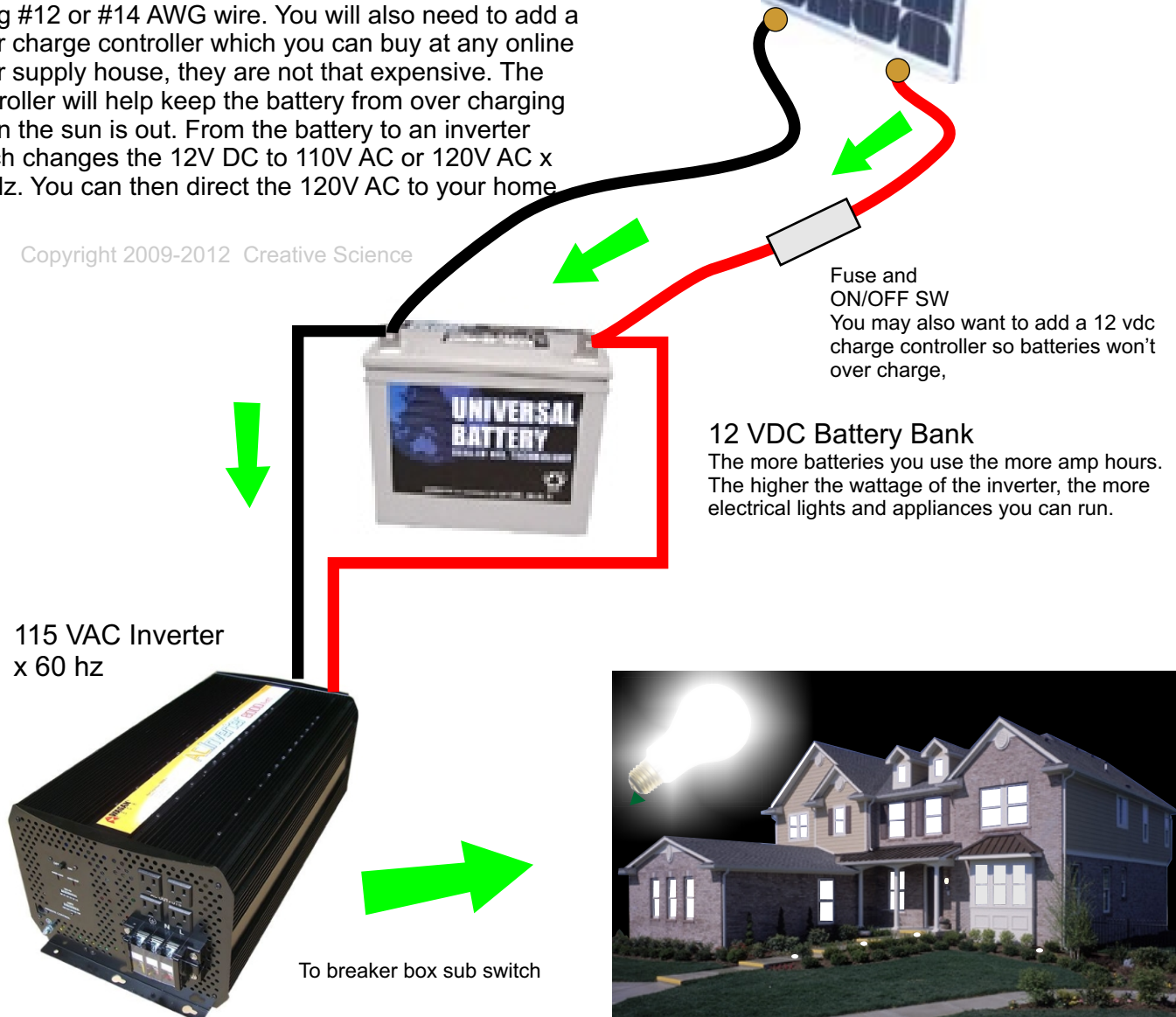

Fuse and ON/OFF SW
You may also want to add a 12 vdc charge controller so batteries won't over charge,

12 VDC Battery Bank
The more batteries you use the more amp hours. The higher the wattage of the inverter, the more electrical lights and appliances you can run.

115 VAC Inverter x 60 hz

To breaker box sub switch

CREATIVE SCIENCE NEWS

PH: 1-812-945-5839

www.FuellessPower.com

- since 1992-

SOLAR CELL OPERATION

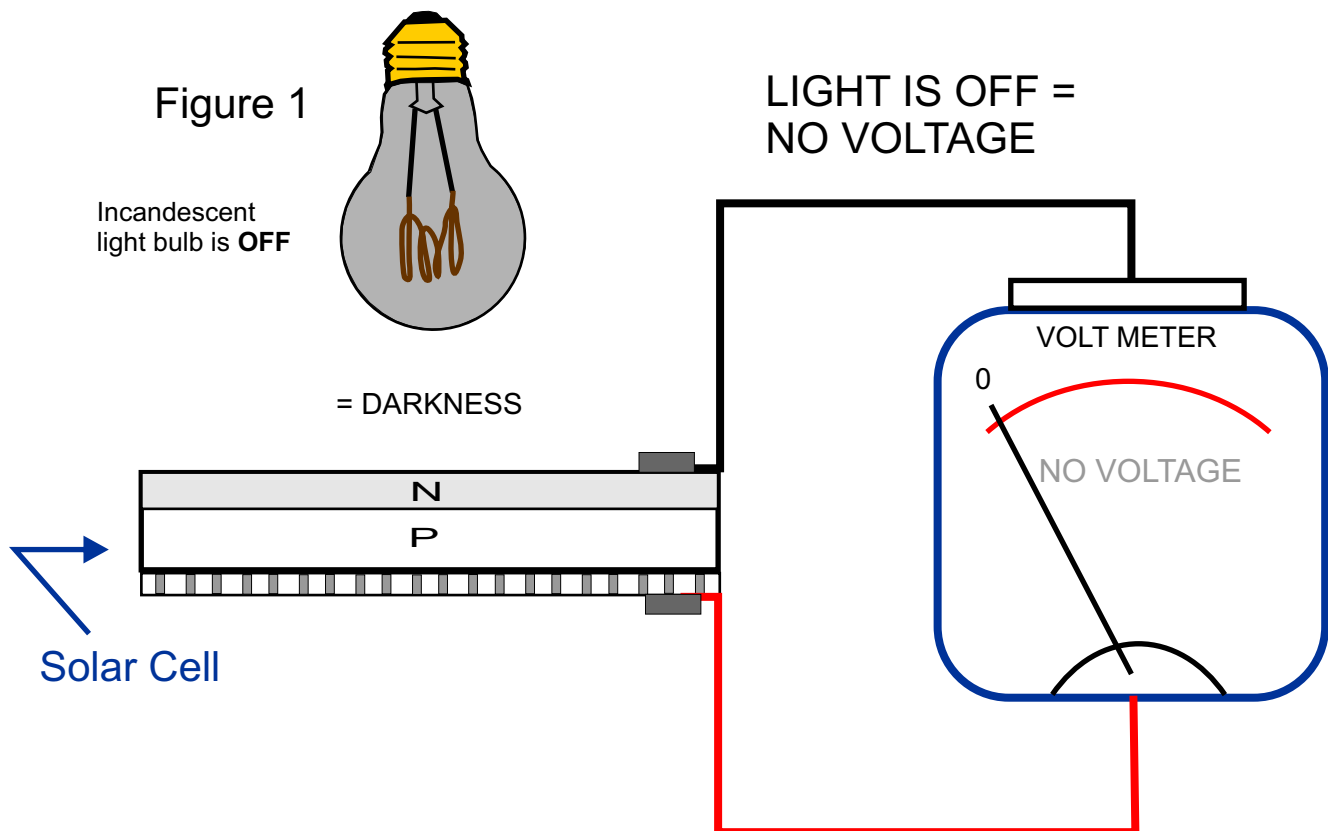

Solar cells are basically large **semiconductor diodes**, and because of the **photovoltaic effect**, Sunlight or an **incandescent** light bulb will convert light into electrical current. In figure 1 the light bulb is off, therefore no light is converted to electrical energy because there is no light to convert.

Next Page >

Creative
SCIENCE

PO Box 557 New Albany, IN. 47151-0557

Also see our **Fuelless Engine** plans \$70.00
order # 362-RC350

& Sp500 AC or DC Generator plans \$70.00

CREATIVE SCIENCE NEWS

PH: 1-812-945-5839

www.FuellessUSA.com

- since 1992-

SOLAR CELL OPERATION

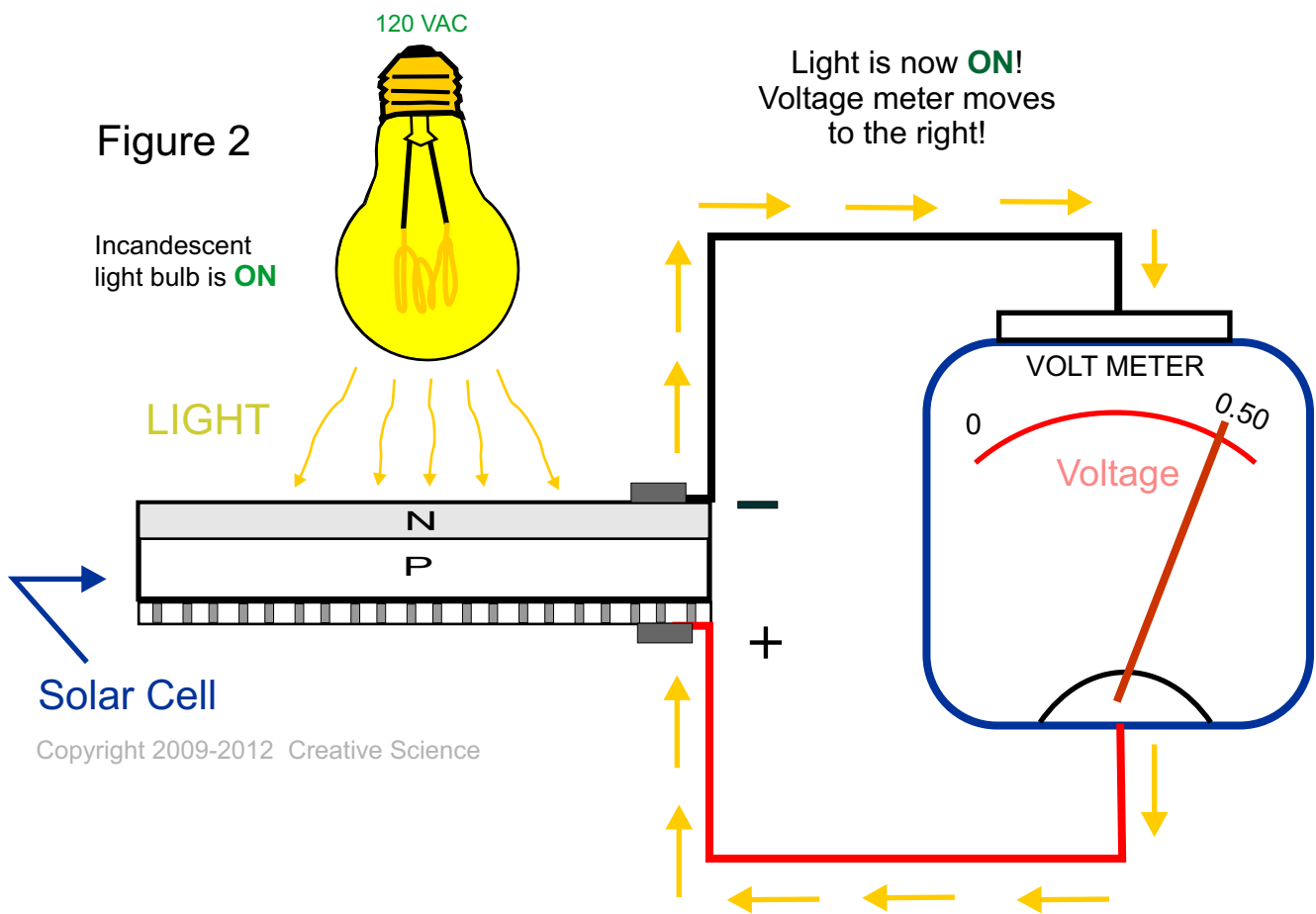

Copyright 2009-2012 Creative Science

Now In figure 2 the light bulb is now ON, and there is now electrical current flowing through the volt meter converting light into electrical energy. The bulb can also represent the sunlight, which = free energy. Cells may also be P on N. Many different kinds of solar cells can be made. Often individual cells are connected in series or can be connected in parallel or both. **See our Homemade Solar cell plans for more information.**

Creative
SCIENCE

PO Box 557 New Albany, IN. 47151-0557

Also see our **Fuelless Engine** plans \$70.00
order # 362-RC350

& Sp500 AC or DC Generator plans \$70.00



Homemade Solar Cells

Copyright 2009-2012 Creative Science & Research

Www.FuellessPower.com PH: 1-812-945-5839

PO BOX 557 New Albany, IN. 47151 USA

HOMEMADE SOLAR CELLS

Learn how to build powerful Homemade Solar Cells using a simple screen printing method!

Also included are step by step plans on how to make dye sensitive solar cells from berry juice!

SCREEN PRINTING SOLAR CELLS

Since you can screen print these cells, size is no limit! Imagine a 24" homemade cell that could be powerful enough to run a 12 volt dc x 3 amp motor using only one cell! Solar cell screen printing has been around for about 15 years or so, and there are many manufactures already doing it as I speak. There are many different types of chemical printing inks to use and many different screen printing techniques to apply it with. But the best I have seen so far was invented by Japan, they have a very simple technique of vibrating the ink after it is printed to get the air bubbles out of the wet ink before it dries. This causes the efficiency of the solar cells to sky rocket!

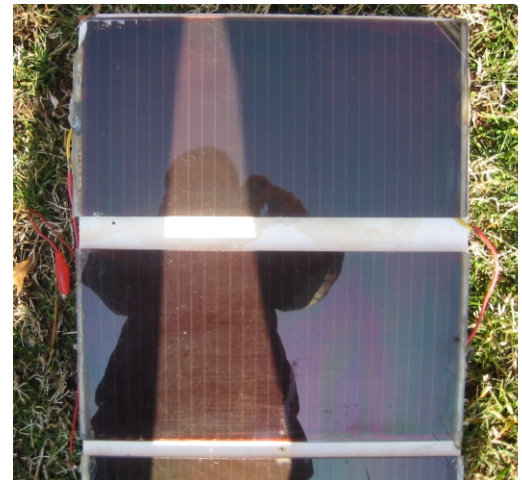

Homemade Solar Cell PlansOnly \$20.95 Order # 401

Screen Printing Video only..... **\$19.95** #402Video

Screen Printing Booklet only.....**\$9.95** #402booklet

A quick example of how a screen printing set up would look like.

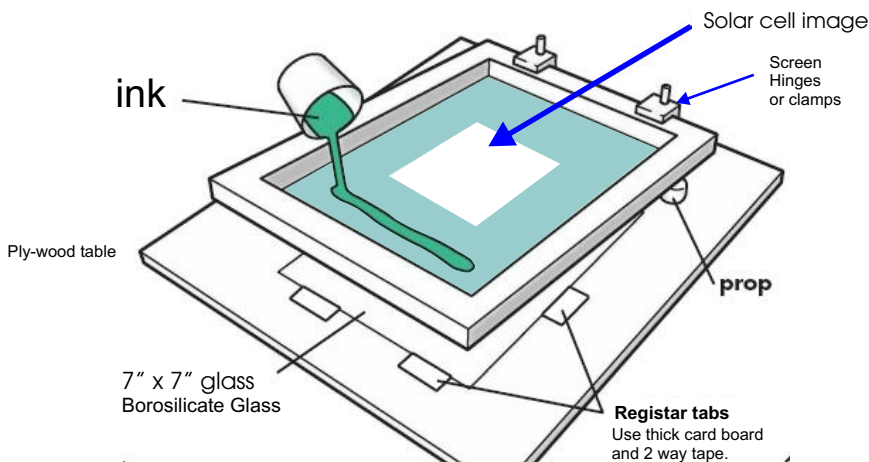

See our screen printing video for more details on how to screen print.
Order# 402V Screen printing video cost \$19.95

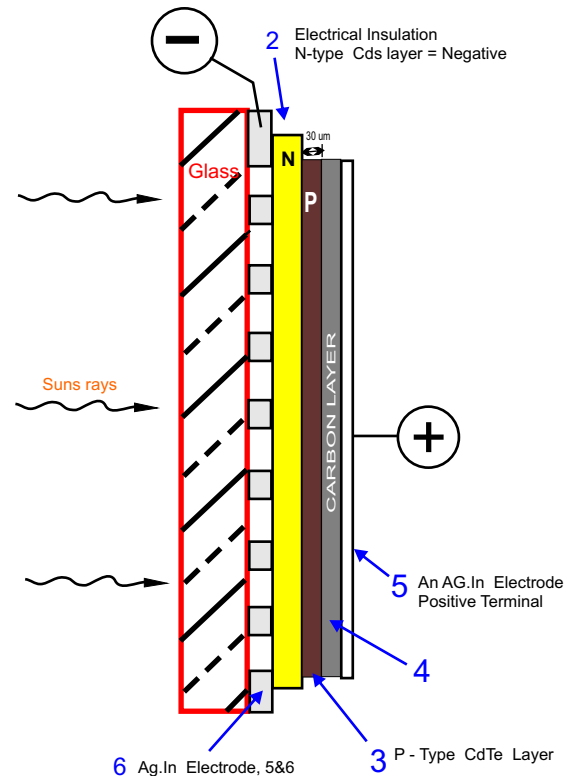



Build A 5 Color T-Shirt Printing Press!

Also great for Screen Printing Solar cells

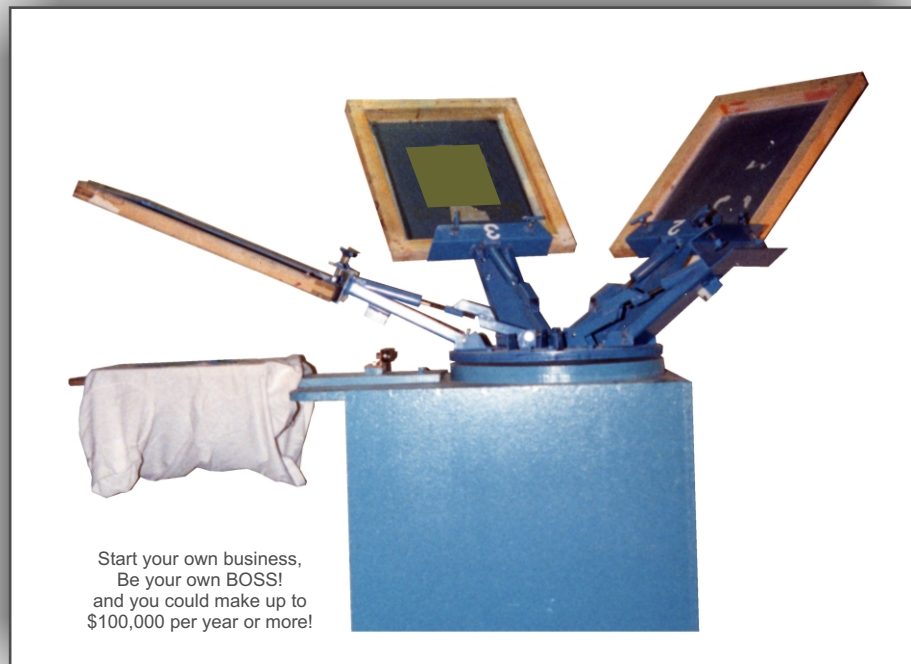

These plans are a must if you are really serious about screen printing. You can even print solar cells with this machine, making it a little faster and easier to produce (but, it is not necessary). Our screen printing booklet shows you how to build a cheap 1 color homemade table top printer for solar cell printing. But, this screen printing machine is for those who want to do a little more and make some money while doing it! With these plans we will show you how to build a 5 color homemade screen printing machine. It's so easy a 16 year old kid could build it. This is a unique space age design and is easy and fun to build. If you are buying the screen printing video, then you will see this amazing printing machine in action! It is included on the video. Cost to construct is only about \$250 in materials. You can print just about anything you want on these printers. No special parts needed. This printer is made of steel, springs, 2 roller bearings, a Lazy Suzan turn table, rocker arms and a wood base. You can get most of your parts from your local hardware store. This screen printing press is for professional and home screen printing use. Anyone can learn how to build it and use this machine, even you! It is a professional printer for screen printing on T-shirts, Signs, Caps, Jackets and more.



Ph: 1-812-945-5839



5 Color Screen Printing Press Plans....Only \$19.95

Order # JCM-1

GUARANTEED TO WORK OR YOUR MONEY BACK!
Plans can be sent to you by e-mail downloading link
or by US postal air mail on computer CD.
Ph: 1-812-945-5839



INVERTER PLANS

Up to 5000 watts is possible!



120V AC INVERTER



12V DC Battery



Use an old computer case for the inverter housing!

LEARN HOW TO BUILD YOUR OWN HOMEMADE 120 VOLT INVERTER!

Connect this Inverter to any 12V DC battery and get an output of 120V AC x 60 Hz or 220 or 240V AC or DC output. The Hertz (Hz) can be adjustable!

As an example, we are using an old computer case for our power supply casing! You can build a simple but powerful inverter with parts you may already have just laying around your house! Very educational and can open an entire new road for anyone interested in homemade inverter Designs. Great for any high school science fair project and inverter research design.



Homemade Inverter PlansOnly **\$24.95** # 579

Plans can be sent to you by e-mail downloading link or by US postal air mail on computer CD.

Ph: 1-812-945-5839



Build Your Own Homemade WINDMILL

Produce enough electricity to run your entire home, with nothing but the wind!

High Efficient!

Designed by David Waggoner of Creative Science & Research.

This windmill is not like the old windmills used before the 1980's. The old windmills never produced enough amperage or wattage to do much of anything. This is truly a new discovery for the 21st century. If enough of these windmills were placed all across the American costal lines, there would be enough power to run the whole entire country. This is new technology! We have yet to find another easy to build high efficiency windmill like this one. You will be amazed at how much free energy this one windmill can produce. We will teach how to make windmill blades that are easy to build. You will love these plans, they are packed full of information. Easy step by step design. Plans will include our high efficiency low rpm generator design. You can even take this generator even further by using super conducting wire for your generator coils! Much more high efficient than copper wire or cooled copper wire coils.

To take this system even one step further. We have now designed a new low rpm generator that is even better than the high efficiency generator included in these plans. (See our Sp500 ac or dc low rpm generator, plans are \$70.00).

Once you learn the secrets of David's new discovery, you can then scale the system up to any desired amperage, wattage or voltage output - AC or DC. 14 volts, 120 volts, 220 volts, 500 volts, 1,500 volts, or 3,000 volts. But windmills are most commonly used to output 14 - 20 volts DC to charge a bank of 12 volt deep cycle batteries. 4 to 7 Batteries are connected in parallel and are then connected to a 110 to 120 volt AC inverter. The inverter steps up the 12 volt dc to 120 - 140 volts DC then converts the DC to AC and steps down the voltage to 110 - 120 volts AC household current. You can build our homemade 5000 watt inverter or buy one on the internet or at any automotive store. You can purchase deep cycle marine batteries from stores such as K-mart, Sears, the internet or a marine boat supply company or store. You do not want to use a 12 volt car battery, they are not designed for deep discharge.

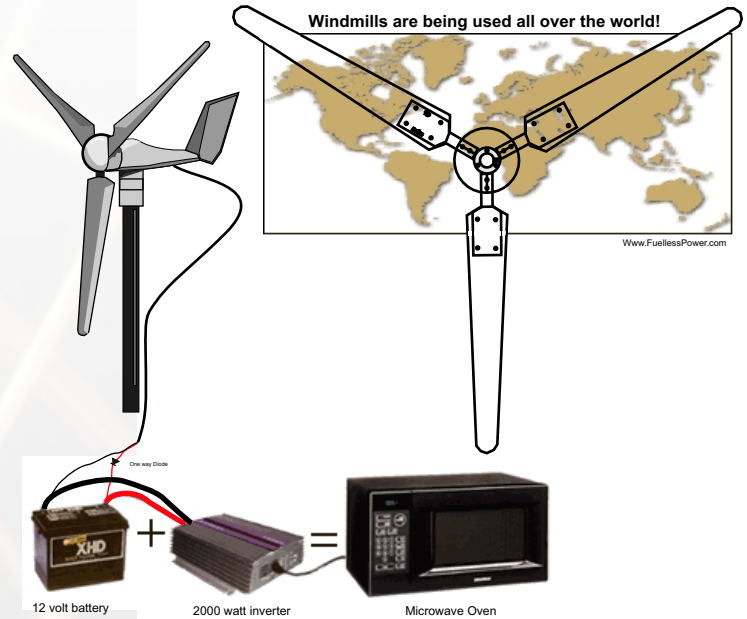

Step by Step PLANS

Only **\$20.95**

Order # 412



GUARANTEED TO WORK OR YOUR MONEY BACK!

Ph: 1-812-945-5839

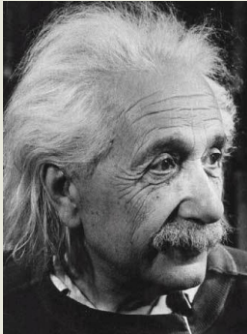

HIGH VOLTAGE POWER SUPPLY PLANS

Learn how to make your own
HIGH VOLTAGE POWER SUPPLY!



Great for many free energy projects. Easy to construct.

Turn 120V AC into 300V DC, 800V DC, 1200V DC or 50.000V DC of earth shaking power! Up to 6 amps. Many uses for the serious high voltage experimenter. Create your own 12' lighting bolts, We used this design for many of our free energy projects! Also great as a high energy weapon against dogs, or for Anti-Gravity research. Very easy to construct. You can connect this HV power supply to a 12 volt car battery using a 120V AC inverter. The inverter steps up the 12V DC to 120V AC, which is then connected to our high voltage power supply.

If you don't know how to solder, you don't need to. We are including a way to build this without the need to solder. Plans come both ways.

This is an easy to build HV power supply that just about anyone can build if you know a little about soldering that's even better. But if you don't and would like to learn, there is a great book that is fast and easy to learn in just one day. The book is called: "**Getting Started in Electronics**" By Forrest M. Mims. This book will also teach you the basics about diodes and capacitors, which is all you need to know build this awesome power supply.

Any voltage over 1200 volts should use non electrolytic type capacitors. You can get 2000V capacitors and high voltage diodes from old microwave ovens for free! Many people just throw them out with the trash. With microwave oven caps, you can make an awesome 50,000 to 100,000 volt power supply. I have also seen old microwave ovens for sale at flea markets as well as Goodwill stores for less than \$11.00 each. If you tried to buy these parts at an electronic supply company, it would cost you well over 200 dollars. The voltage multiplier in these plans are easy to build and low cost if you buy surplus capacitors and diodes from the Internet.



Ph: 1-812-945-5839



HV Power Supply PlansOnly **\$14.95**

Order # 378



HIGH VOLTAGE PLANS

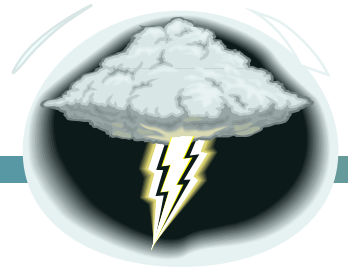

MAKE YOUR OWN High Voltage Capacitors

200 - 50,000 volts



High Voltage Capacitor Plans **\$ 14.95** order # HVC1

Great for many free energy projects! These plans are packed with more information than you may use in a life time. A must for many free energy devices. Great for many anti gravity lifters experiments, or one could say anti gravity air craft projects as well. Includes many different designs and safety info. It's easy to scale these designs up to any desired voltage or capacitance.

All our plans are available on computer CD or by e-mail download link.

Capacitors that recharge themselves!

This is FREE ENERGY that many research groups already know about. Building this type of capacitor is like building a permanent magnet, in that it acts to have energy even after you discharge or release its energy. But the energy coming from it's plate's is electrical! Up to 20,00 volts DC. PLANS \$9.95 order # H757

It is claimed by some to charge, discharge and then recharge over and over up to 12 yrs!

High Voltage Electromagnets

You can build them to any size or power range you desire! The plans also show a homemade automatic coil winder. Wind as many coils as you want very quickly and easily!



Plans **\$16.95** order # HVEMP

Video w/plans **\$19.95** # VPEM

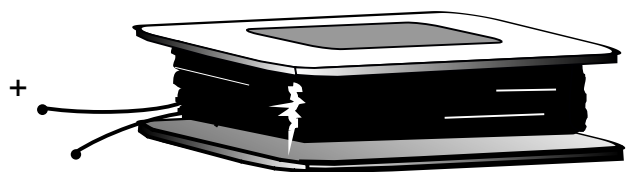



The High Efficiency **GENERATOR**

This generator is not our powerful SP500 Generator, but it is great for research purposes and exposes new ways to generate electricity with no moving parts. Very educational and can open an entire new road for anyone interested in AC / DC generator technology. A must for any research group or high school science fair project.

Plans only **\$16.95** # HFG9



SP500 Step by Step Plans only **\$70.00** # Sp500

High Efficiency Generator



Homemade Batteries

Great for emergency back up lighting, shelf life is about 70 yrs!
Also great for School Science Projects as well as serious HV research.

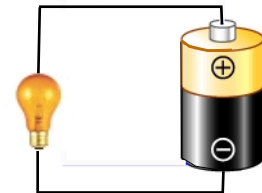

Make your own homemade batteries. Learn how to build a Clorox Bleach Battery. This type of battery is very powerful! The plans will teach you the proper Clorox mixture and show you how to construct batteries using PVC pipe from a hardware store. Clorox Bleach batteries are very powerful but they only last a year, the metal copper corrodes too fast. But there are other metals we found that you can use in plain tap water that corrode more slowly, such as stainless steel or nickle.

You can use plain tap water as your main source of power! It maybe possible to simply fill up the batteries with water every 3-6 months. We estimate battery life to be up to about 5 to 10 years. The water and the 2 metals will produce the electricity, therefore you will never need to charge these batteries, just refuel them with water!

Plans only **\$14.95** order #396

Plans are well illustrated and professionally done. You can order by mail or credit card.



Free Electricity From **THE SKY**



Free Electricity from the Sky! The entire earth is being bombarded with high and low frequency electrical energy. Some of that energy is from TV, Radio, Microwave satellites, Cell phones and 20,000 volt electrical power lines etc. Electricity moves through the air all the time. Even before these inventions the earth has been bombarded by electrical energy traveling through the air, from the sun, the stars, and within the earth itself. There is over 20,000 volts of electricity in our upper atmosphere all the time, surrounding the earth just waiting to be tapped into and many thousands of people are already doing just that. This system has been used for years by big brother, for hidden FM transmitters etc. It is possible to get enough energy to run motors, lights and more. David Waggoner heard of a man that lives high up in a mountain area who ran a large cable up to the highest peak and connected it to a large metal grid, the other end was connected to his ground by his cabin, which provided enough electricity to run his whole entire cabin!

Plans \$14.95 order # 371

Burnt Out Fluorescent Fluorescent Light Bulbs



Burnt out Fluorescent Light Bulbs! Don't throw them out! Reuse them!

David has two brother's that are also into scientific research. One of his brothers invented a way to relight fluorescent light bulbs! You can use them for a life time and they will never go out! You will never need to throw away another fluorescent bulb ever again.

Plans \$9.95 order # 377

Make Your Own Light Bulbs!



A very fun science project for the whole family! It's easy. Never buy another light bulb again! Information bulb manufactures may not want you to know? Some Edison bulbs we are told can last 50 times longer than the bulbs sold today!

Plans \$9.95 order # 386

500 volt Power Supply!

500 VOLTS DC From a bicycle generator, easy to build! Generates an enormous amount of earth shaking power. Attach to a bike or you can simply turn with your hand. 50 kv to 100 kv is possible by scaling up this design!

Plans \$7.95 order # 373



FREE ENERGY FROM THE EARTH

Copyright Creative Science 1996 - 2012



We have found that the earth is loaded with electricity!

These plans are loaded with information that you may not find anywhere in the world! When you receive these plans you will be able to quickly build a homemade device or devices that will produce electricity or electrical currents that can charge batteries, capacitors or light small white LED light bulbs. It is very possible to get enough current to run a small garage or home, but, it would take a little more time to build and construct. If you are interested in running your entire home it is cheaper and easier to build our Fuelless Engine and our SP500 AC or DC Generator.

The information in these plans are intended to educate everyone in planning for emergencies. They are great for low lighting during long blackouts. You can cheaply use the earth as a generator to light your entire home with multiple super bright LED white light bulbs. These bulbs are not as bright as a 60 watt bulb, but just one bulb is bright enough to light up an entire room during emergencies. Very easy to install and to wire LED bulb's all around your house. LED bulbs can last up to 70 years and only use small milliamps of power to run. Most of these bulbs will run on 5 volts or less. To much voltage can burn them out. But the earth can be made to output a steady 4 - 5 volt DC current. You can purchase these bulbs anywhere, Electronic supply stores, hardware stores, Walmart stores etc. You can also buy small LED white flash lights just about anywhere. It is much easier to use them already manufactured in a flashlight container and is more attractive for your home. After you purchase our plans, you can start getting free energy from the earth in less than one hour!

Free Energy from the Earth Plans.....only **\$19.95**

Order # 459



Plans can be sent to you by e-mail downloading link
or by US postal air mail on computer CD.

Ph: **1-812-945-5839**



PERMANENT MAGNET MOTORS!

Free energy using Radio Shack ceramic bar magnets. Learn how to build 2 simple motors that will actually move by the free power of magnets. You will learn the correct way to angle the rotor and stator magnets. The plans will explain why and how they work. The horse power will depend on how strong your magnets are. These plans are for research purposes only. I have spent many nights awake learning how to use these magnets, many hours of research have gone into these 2 simple designs. Also included as free news is the Howard Johnson perm magnet motor. Learn how to build from this 1980 article.

“ David Waggoner “

FOR RESEARCH PURPOSES ONLY!



Available on Computer CD or Paper

Only **\$19.95**

376

Perm Magnet Motor Plans

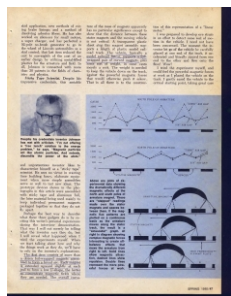

FREE ELECTRICITY from the PHONE CO.

David Waggoner has invented a way to pull enough electricity from the phone company to light a 150 watt light bulb, and it's all legal! He has developed a way to charge batteries and still use your telephone without any problems. David's special circuit design is easy to construct and will give you awesome results!

Plans only **\$9.95** Order # 359

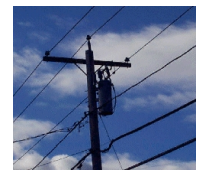

Anti-Gravity UFO Aircraft (Fact!)

David was concerned about offering this US Patent, he was not sure how some customers would react! But this US Patent is proof that they are real and do exist! We are offering just one of many hidden to the world! This official US patent will show you that the United States Government has indeed known about them for many years. An Official US PATENT dated April 1967.

Actual drawings and plans of a USA - man made **UFO flying saucer.**

US Patent only **\$9.95** #409

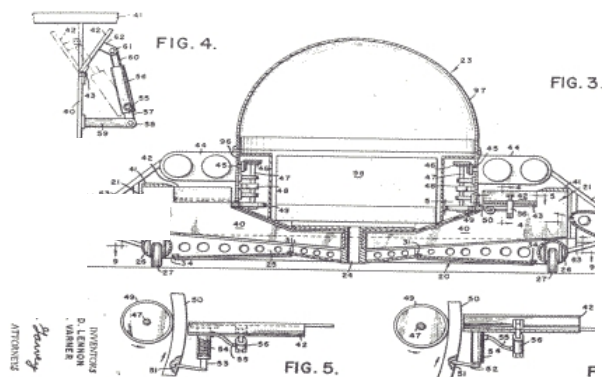



FREE ENERGY DEMO KIT PLANS

As seen and demonstrated on our online video!

Free energy proof!

We have been researching alternative energy for over 18 years now, and have met many skeptics along the way. We have actually had people write us telling us that "there is no such thing as free energy"! Is that what you believe? If so, what about solar cell technology? Windmill technology? Radiant energies? The Sun, The earth, and so on. There is so much free energy all around us 24 hours a day 7 days a week that many do not even notice it. So to silence some of the critics David has made this simple but powerful free energy demonstration device that can be seen on our website for all to see. He is not trying to hide anything. The pyramid is only for looks. David just likes the way they look and has been using them in our plans and videos for over 14 years.

Free energy motors and generators will be the wave of the future! If you have seen the video and would like to build this device for yourself we are now offering the plans for only \$16.95. It is easy to build. You do not have to use expensive Polyethylene white plastic. Wood can also be used and will give you the same results. The plans are step by step and loaded with all the information you will need to successfully built this device.

This demonstration device will be great for showing your friends and family. They will be able to see free energy being created right before their very eyes. It is fun to play with and fun to build.

Plans can be sent to you by e-mail
downloading link
or by US postal air mail on
computer CD.
Ph: 1-812-945-5839

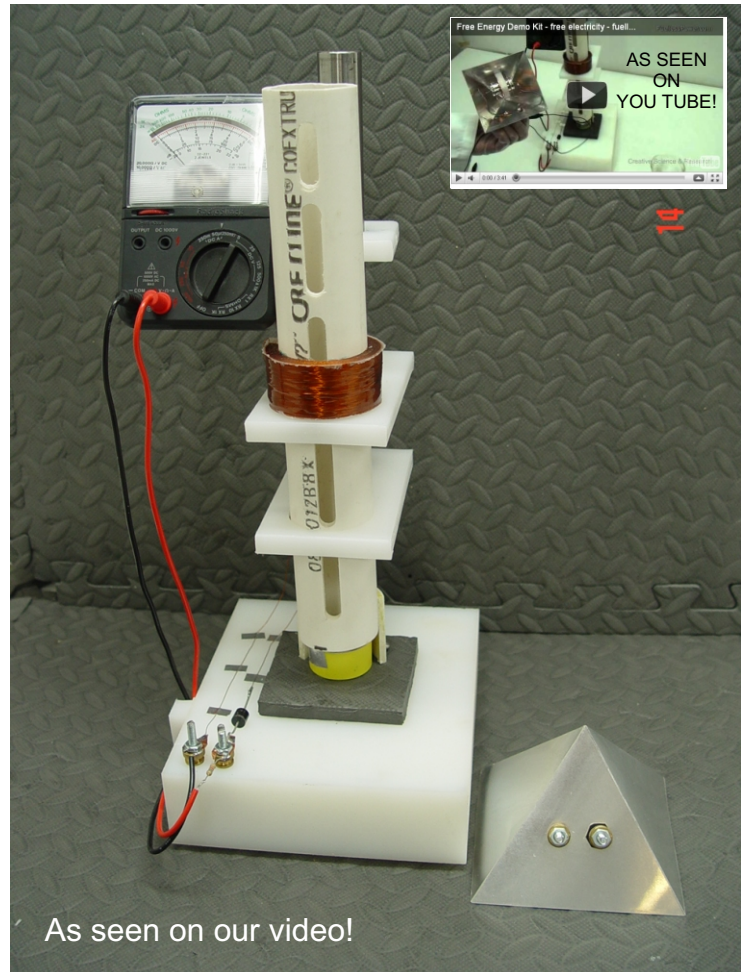

As seen on our video!

Free Energy Demo Kit Plans

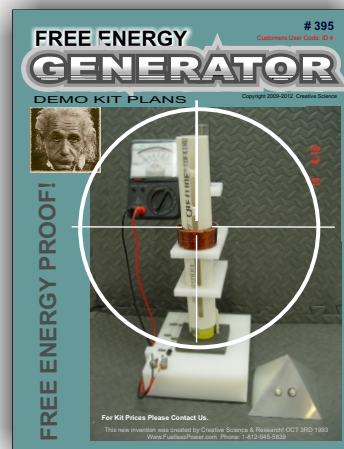

Plans only
\$16.95

Order # 395

60 pages long



US PATENT / Tesla Turbine Engine

The Tesla Turbine:

Learn how to build a Tesla turbine engine. Many of our customers already have! This engine will amaze you! A 300 hp engine could be possible which is no bigger than a man's hat. It has been told that Tesla built an engine that could fit in the palm of your hand and can produce 300 hp at 2,000 rpm's! It is powered by air or compressed Steam. This engine can be easy to build and geared down to power a home generator or a car or an electric car. Great as a super high efficient steam engine to power any home generator system. Simply use an old pressure cooker filled with water. All You will then need is fire wood and a high pressure line coming from the pressure cooker to the Tesla turbine engine which can then be connected to a 120 v ac or dc home generator or our Sp500 AC generator.

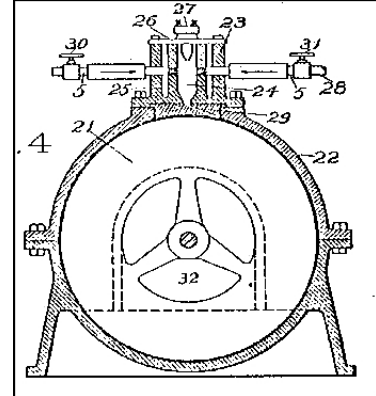

Invented by Nikola Tesla in the early 1900's and suppressed!

US Patent Only \$11.95 #393

See our website for plans that are not included in this catalog. See us at: www.fuellessUSA.com or www.fuellesspower.com

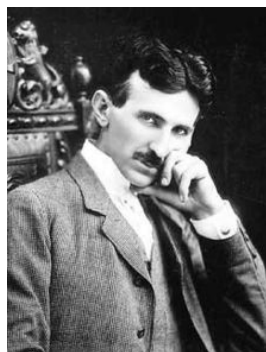
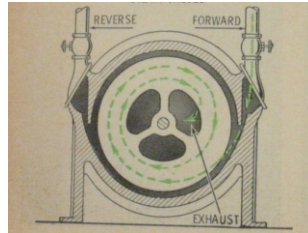

Nikola Tesla

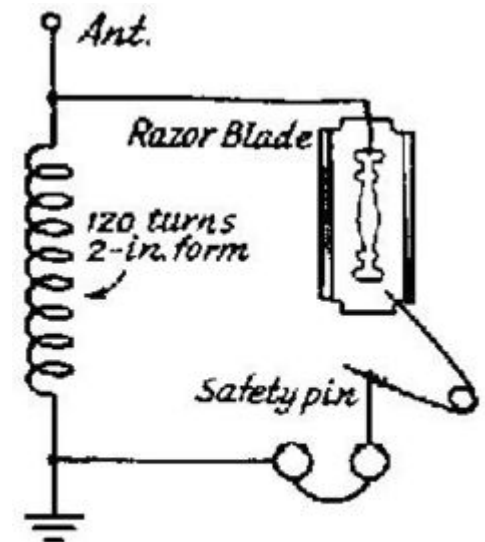
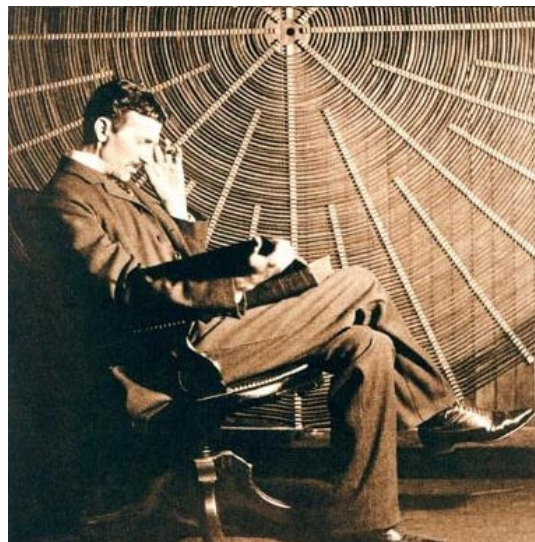

Fox Hole Radio



The Fuelless Gravity Motor

Rated at up to 500 RPMS:

The Fuelless Gravity Motor is what we invented before we discovered the Fuelless engine on page 2. You will not be able to run a car with it, but you can build one to generate electricity.

This motor uses gravity and balance as its main source of power and unlike many so called Gravity engines out there, this one really works! In 1991 we did a patent search on this device and we found no other gravity engine like it. This device does use a small input of electrical power to get the free energy reaction started. Most free energy devices we have seen, all use some form of energy to get the free energy reaction started. The only free energy device I have seen that does not use input energy is an all permanent magnet motor. This device is easy to build and will amaze all your friends.

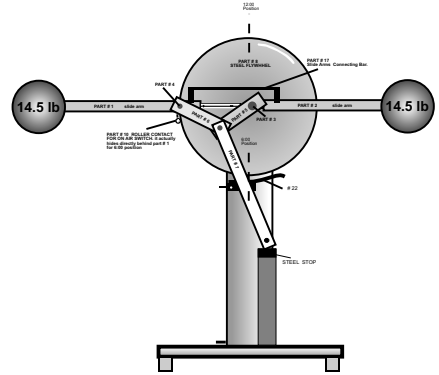

GUARANTEED TO WORK OR YOUR MONEY BACK!

DVD VIDEO

Only **\$19.95**

* Available on DVD or CD only
FGE3

Step by Step Plans Only **\$16.95**
Order # FGE2

Video is not yet downloadable at this time, but can be sent on a CD or DVD disk by air mail.

High Voltage Electromagnets

Will handle up to 800 volts 1-4 amps at 60 KHZ Size 2"ht x 4" L x 3"w

Made with a special hard to find iron core!

These magnets are great for many free energy devices and many other science experiments.

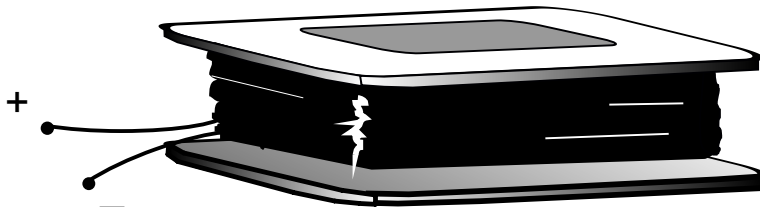

PRICE: \$.....Call or write us.

Order # HVEM

Creative Science & Research P.O. BOX 557 New Albany, IN. 47151
(See last page for ordering information)

NEW

CD Package Deals

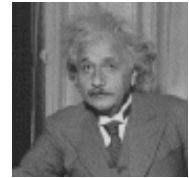
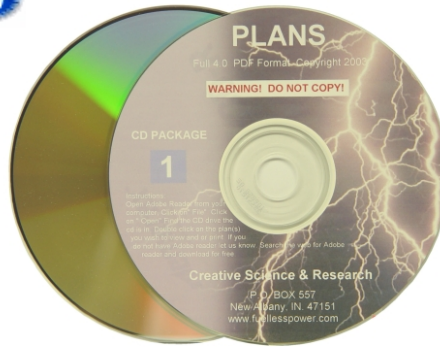

Plans are sent to you on a CD Computer disk in PDF Adobe Format, You can then view them and or print them out from your computer. We also offer a download option.

If you have already ordered from us before, you can deduct the amount you paid for the plans only, do not include the shipping you paid or any videos. Not to exceed \$125 or CD will be full price.

1. CD Package #1 Includes **all 33 plans** & 4 videos offered on our website!
All 33 plans& Videos only **\$300** you save over **\$351.60**

Includes every plan we have on our website and catalog, plus 1- Fuelless Engine Video & 1 - Heater Video

As a Bonus we are including our New Sp500 AC Generator Plans!
A \$70 value!

LOADED WITH INFORMATION!

2. CD Package # 2 Includes 17 plans only **\$150** you save \$120

CD # 2 Includes:

#362 The Fuelless Engine (low hp), #878P The Fuelless Heater, #579 The 5000 watt inverter, #400 The Air Engine, #401 Homemade Solar Cells, #402 Solar Cell Screen Printing Booklet, #396 Homemade Batteries, #FGE2 The Gravity Engine, #376 Permanent Magnet Motor, #393 The Tesla Turbine, # Hfg9 High Eff. Generator, #386 Make your own light bulbs, #HVEMP HV Electromagnets, # Ffwh Fuel from water part 1, # Smw Fuel from water part 2 #409 Anti-Gravity Aircraft Patent. #HVC1 HV Capacitor Plans.

Please Include shipping charges see our catalog or web order form.

To order see our website or fill out the order form on the back page and mail to us.

Creative Science & Research
PO BOX 557
New Albany, IN. 47151-0557

www.fuellesspower.com

or www.fuelless.com / E-mail us: SalesDept@FuellessPower.com



Creative SCIENCE

& Research

E-mail: SalesDept@fuellesspower.com

PO BOX 557 New Albany, IN. 47151 USA

www.FuellessPower.com

All our plans are now available on CD in .PDF format or Downloading.



ORDER FORM



Name _____

Address _____ City _____

State _____ Zip _____

* E-mail _____ Country _____

Credit Card # _____ Expiration Date: _____
Month Year

Credit Card Type: _____ * Phone # _____
Visa, Master Card

Send my order by: E-mail Downloading

By US Priority Mail

Please select a box(s) below.....

Order Number	Qty	Item Description	Price Each	Total
1				
2				
3				
4				
5				
6				
7				
8				
9				
10				
11				
Shipping charges		MERCHANDISE TOTAL		
\$9.95 USA / Canada Air mail		Shipping charges		
\$ FREE download processing Fee		TOTAL AMOUNT		
Orders outside the USA \$14.95				

Send Plans to me on Computer CD

Send VIDEO(S) to me on Computer CD

Send VIDEO(S) to me on DVD

Guaranteed to work or your money back! Personal check, Cash or Money Order.
 Postal money orders are faster, see your post office for details.